

One supplier provides everything that is needed:
Your system integrator for signalling systems **ZSB 2000**



SCHEIDT&BACHMANN 



Maintaining values to create a sustainable future: Tradition and innovation – trademarks of being a global market leader



A company with heritage and character

- Founded in 1872
- Number of employees: > 2,000
- Developed from a mechanical engineering company to a global systems provider
- Global market leader with future-proof system designs
- Continuous investment in innovative production technologies
- Continuous investment in highly qualified employees



From the beginning, Scheidt & Bachmann has held high the standard of being a reliable partner to its customers based on continuity and farsighted vision.

Since its founding in 1872, Scheidt & Bachmann has become a global solutions provider. The company's worldwide success is due to its innovative vision and customer-oriented approach.

We take development one step further

At Scheidt & Bachmann, it is our tradition to plan our company's development so that it is both consistent and long term. Since our early beginnings as a mechanical engineering company, we have made significant targeted investments in the continuous training of our employees and in highly developed state-of-the-art production technology. From manufacturing of level crossings, signal boxes and signalling systems for railways, the company expanded in the 1930s to the construction of fuel pumps. Since the 1960s the company has been developing and delivering access control systems for multi-storey car parks, swimming pools and leisure facilities. The trend towards automated fare collection systems at the end of the 1970s led to the forming of the company's fourth division, Fare collection systems. Systematic driving forward of innovative processes and continuous improvement has enabled

Scheidt & Bachmann to evolve into a global leader in its chosen fields. The result is that our system solutions meet all international standards. Also by adopting a modular systems architecture the Scheidt & Bachmann customer has piece of mind that their investment is future-proof to meet the standards of the future.

Giving our best, together

A pioneering spirit and the continuous improvement of our products have transformed us from what was once a mechanical engineering company to an international system integrator. This success is not just possible thanks to state-of-the-art technology, but our highly qualified employees also contribute to this effective concept. The result: For five generations, the company has been run by the founding family and many of our employees have been connected to the company for generations.



From a passion for perfection: Worldwide know-how for you on site

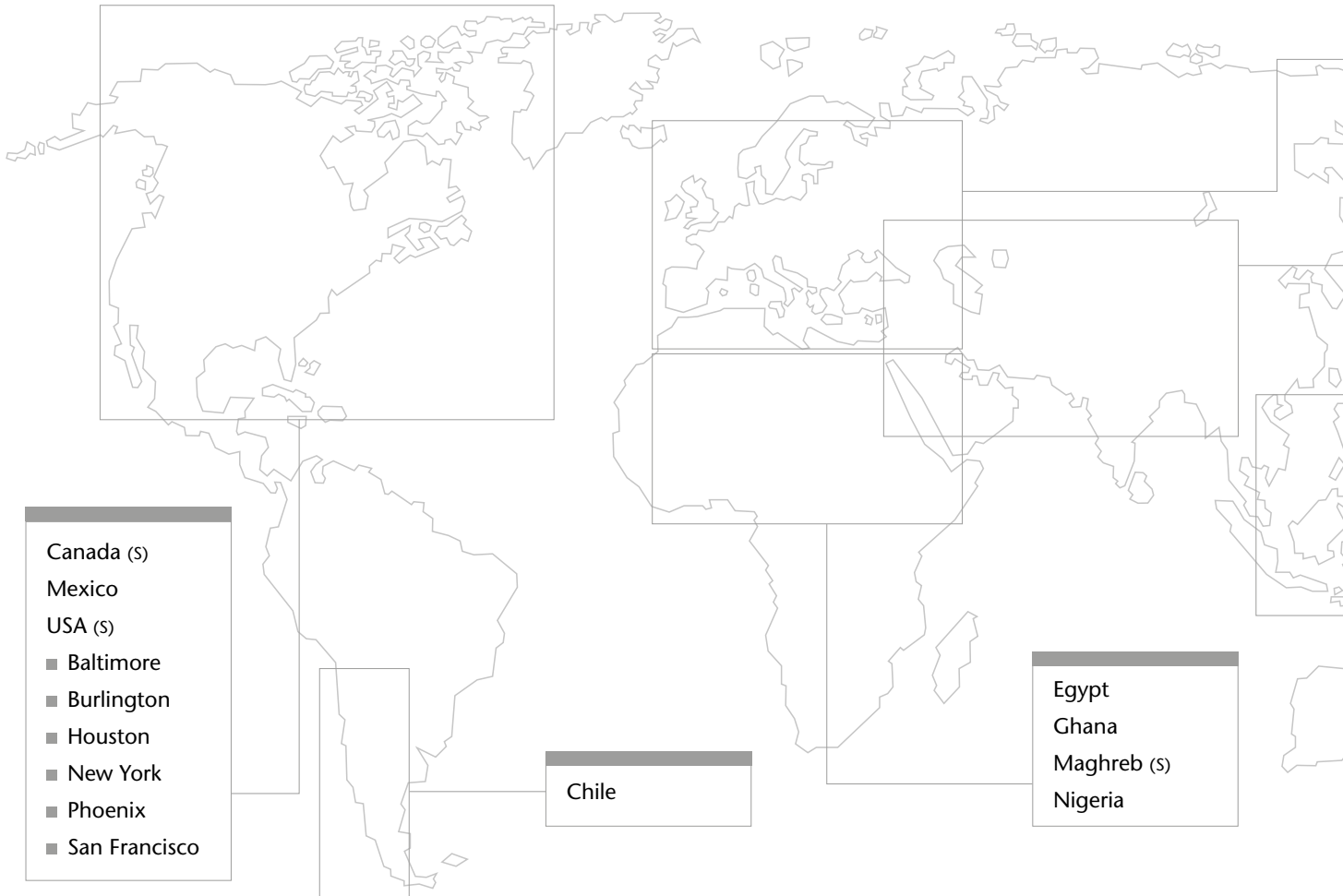

Scheidt & Bachmann is known throughout Europe as the reliable partner of international mineral oil companies and independant forecourt operators. As one of the market leaders in our sector, we are proud to be able to reflect on strong customer relationships forged over many years. Scheidt & Bachmann are recognised throughout the sector as experts in systems for all aspects of forecourt operations.

Our solutions are your advantage. Our customers can rely on this promise, for us, it is not only current market standards that count, but much more our customers' demands. For this, we are continually developing our products so that we can constantly offer our customers

modern solutions for successful forecourt management.

With our own R&D, production and quality assurance departments, we ensure that our products maintain their position at the leading edge of technology and can offer our customers individual solutions for their forecourt business.

Our membership of national and international industry committees means that we are kept informed of legal and legislative requirements relating to technical changes well in advance, and can offer this knowledge as consultative partners to our clients.

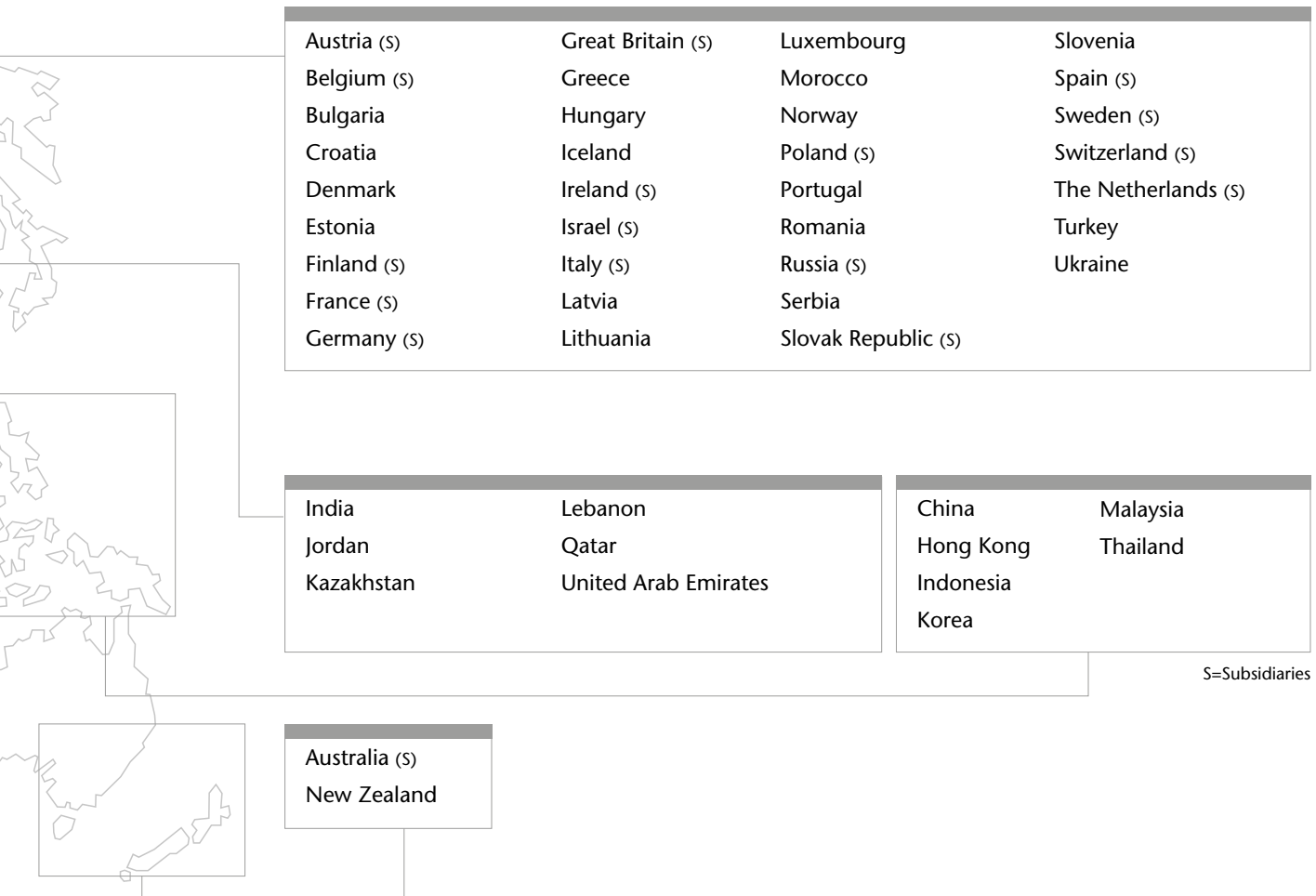

Thus our signalling system business area provides holistic track solutions with a standardized hardware configuration, a standardized service concept, standardized operation control and a centralized control and monitoring for smooth-running and customer-friendly operations.

Our extensive sales and service network throughout our own subsidiaries and agencies ensure that we are always present nationally and internationally.

Scheidt & Bachmann is made up of four – largely independent – business sectors

 **Parking and leisure centre systems**

 **Signalling systems**

 **Fare collection systems**

 **Petrol station systems**





- 02 | 03 **Maintaining values to create a sustainable future:
Tradition and innovation – trademarks of being a global market leader**
- 04 | 05 **From a passion for perfection:
World-wide know-how for you on site**
- 08 | 09 **Safety is certain
ZSB 2000 – an IECC and more... Communication via „intelligent“ interfaces**
- 10 | 11 **Range of functions
Distributed system concept and optimum adaptation**
- 12 | 13 **Central management
Operational Management; Control- and operating system acc. to SILO system architecture**
- 14 | 15 **Efficiency
A+++ New standards in energy efficiency and sustainability**
- 16 | 17 **System components
Modular system concept Number of components dependent on the particular project**
- 18 | 19 **Field level elements
Signalling concept
Vehicle capturing concept**
- 20 | 21 **Field level elements
Local Man Manual User Interface (MMI) concept
Service concept**
- 22 | 25 **Synergetic effects for our customers:
Our systems for a mobile world**

Safety is certain

Z3B 2000 – an IECC and more...

The train has always been one of the safest forms of transport. Railway signalling techniques play an important role in reliable track safety. Scheidt & Bachmann is one of the most successful manufacturers in this sector with its more than 130 years of experience.

Rail and infrastructure operators in various countries trust in this technology and operate an integrated track concept on this basis of network capable and computer-controlled systems. Subsystems and individual solutions can however also be easily realised and adapted thanks to modern and flexible technology.

The interlocking system **Z3B 2000** and its electronic field components offers everything in regards of modern

operation management demands, despite its very compact construction. The clear separation between hardware and software and their modularity allow a flexible and affordable solution that can be used on main lines as well as on branch lines or on inner-city and industrial railway lines. With the consequential use of state-of-the-art technologies and perfect adaptation to the respective customer requirements, energy and life-cycle-cost optimised solutions are made possible.

Alongside the main task of controlling and monitoring train movements, other tasks that are not typically part of rail protection measures (e.g. passenger information, switches heating, station platform announcements and lighting) can be realised from the start in the track concept as well.

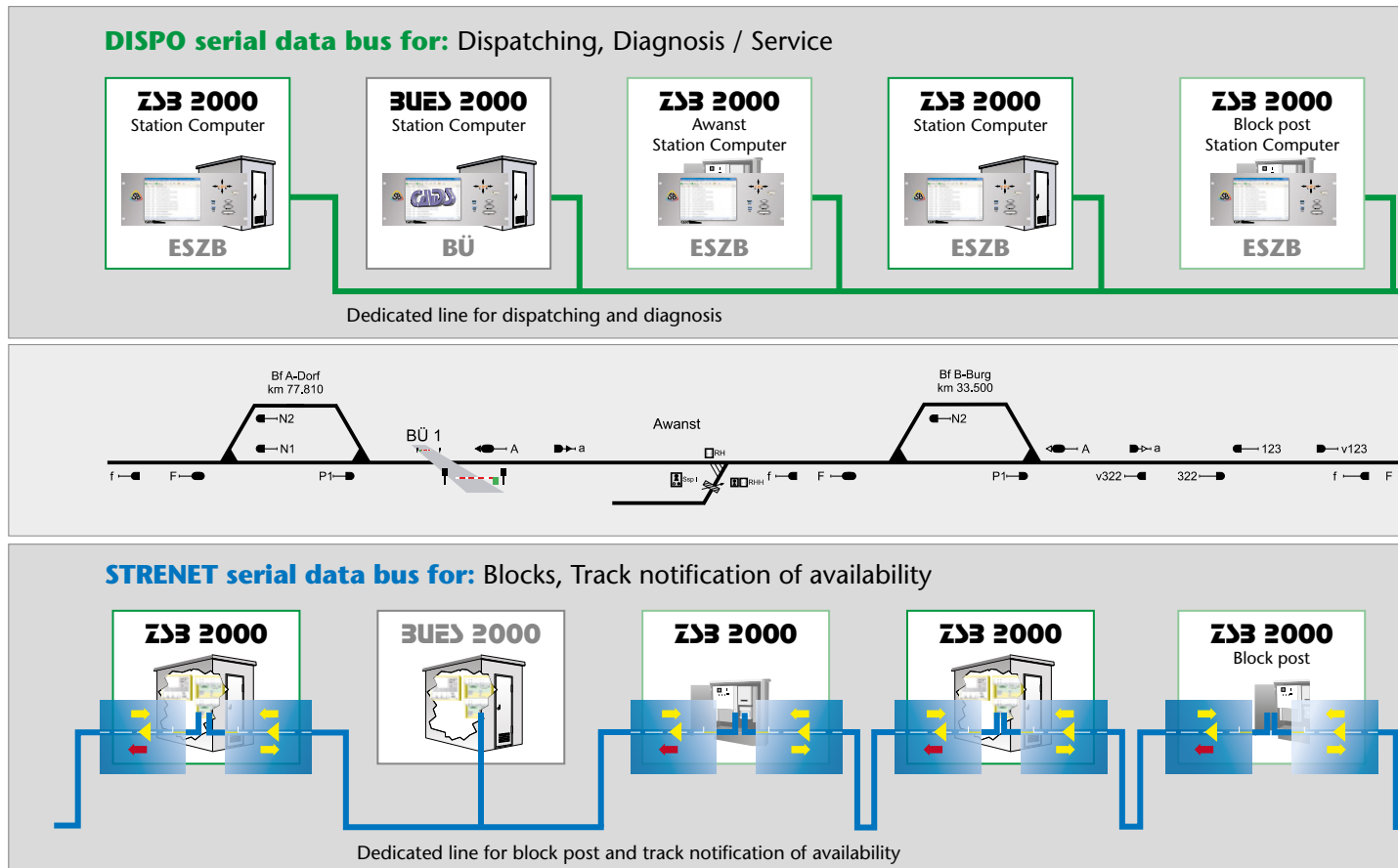

Communication via “intelligent” interfaces

The interlocking system **Z3B 2000** from Scheidt & Bachmann is suitable for operating procedures according to train operating regulations and for train control operation, and has the corresponding approval for use on main lines and branch lines in several countries.

With the modular system concept and the consequential software-based realisation of functions, the interlocking system **Z3B 2000** is very flexible and can be quickly adapted to customer requirements. All of the usual traction types on tracks equipped with the **Z3B 2000** can be used, and operation on electrified tracks is also possible. There are generally two communication interfaces available for time and cost optimised connections between all operating points found on the track. These are listed as “intelligent

interfaces” (bus) and with the data exchange based on telegrams, a very large information depth with minimum cabling work is possible between the operating interfaces along the whole track. Alongside the operating points of the train station, passing point junctions (AWANST) and block adaptation, level crossings (**3UEB 2000**) can also be directly connected to these interfaces. This means that continuous track cabling using rail flange cabling make sense for the first time and therefore opens up savings potential in investment costs.

Due to the contents to be transmitted, two “intelligent” interfaces designed as a bus are used:

While all operating points along the track and the neighbouring train stations communicate safely with each other technically via the track network bus (STRENET) using logical point-to-point connection and encryption algorithms, secure data exchange with the operating or servicing control centre is realised via the dispatching bus (DISPO) using secure display proceeding. In addition, data from other systems to be transmitted along a rail track can also be transmitted via the DISPO interface, which leads to pooling of communication paths and is therefore cost-efficient. For example such data can be produced for passenger information, switches heating systems or station platform lighting control.

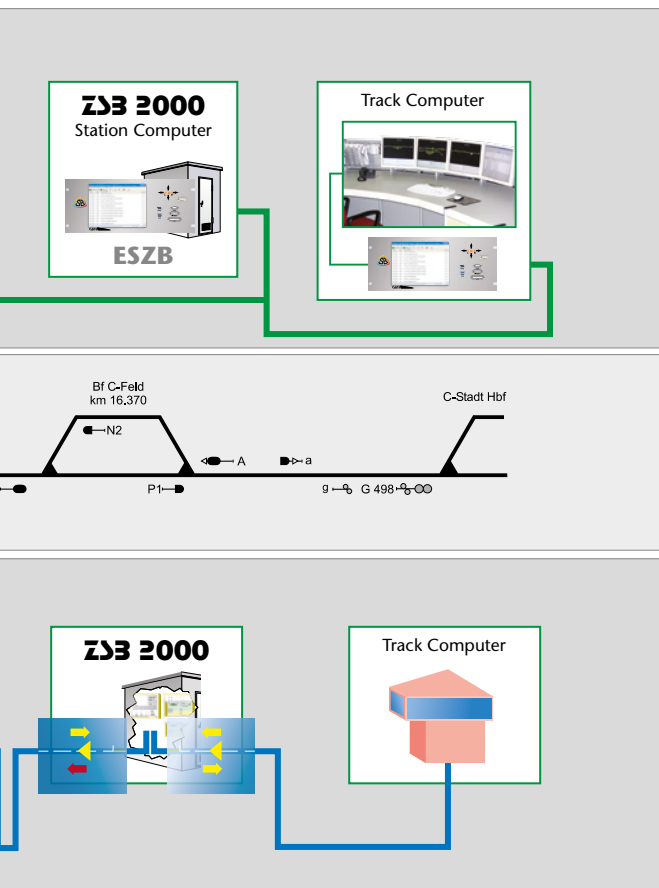

Range of functions:

Decentral system concept and optimum adaptation

The Interlocking **Z3B 2000**, which amongst other things is approved by EBA, works both in the train service regulations operating procedure (e.g. in accordance with the DBAG regulation KoRil 408) as ESTW-R but also in the signal-controlled train control operating system procedure as interlocking system ESZB (e.g. in accordance with the DBAG regulation KoRil 437) and is installed and networked along the track/line in accordance with a decentral system concept. Which operating points along the track are to be used and which modules are required is specific to the project and customer, whereby each system is generally implemented on the same platform and can be divided into three levels.

The comprehensive track tasks are listed in the dispatching and diagnostics level. Communication between the safe interlocking level of operating points along the track takes place via the track network bus (STRENET) as a logical point-to-point connection. The individual **Z3B 2000** operating points control and monitor the local operating processes at the safe interlocking and field level. The elements of the field level are linked with the interlocking level by a serial standard interface; the element bus (EBUS) as a CAN bus.

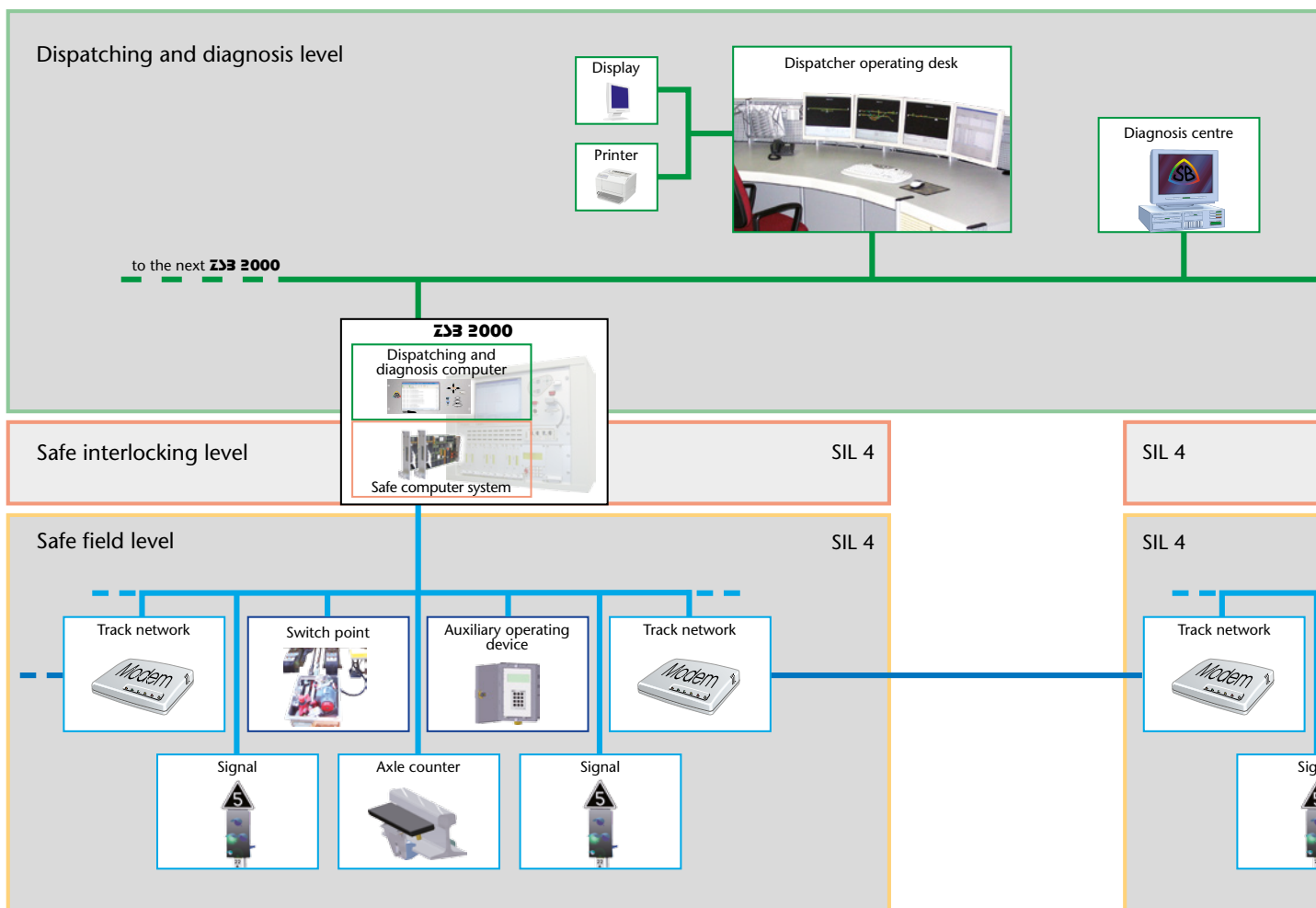

On lines with **ZSS 2000** the following operation points may be applied:

- Station
- Block post
- Passing point junction
- Block adaptation at the start and end of the section

Each of these operation points works in a stand-alone manner with a safe system core and controls a project-dependent number of field elements.

In the functional scope of the interlocking **ZSS 2000** the following elements are processed:

- Electrically remote-operated switches
- Electrically remote-operated scotch blocks
- Single-slip and double-slip switches
- Spring switches (trailable points)
- Electrically locally operated switches and scotch blocks
- Manually operated switches and scotch blocks with key requirement
- Train routes
- Shunting routes
- Close operation areas
- Interlocking route safety
- Overrun length paths
- Main signals
- Distant signals
- Multi-section signals
- Speed indicators
- Shunting signals
- Protection and obstruction signals
- Supplementary signals
- Automatic train control
- Track clear detection with axle counters
- Blocks
- Auxiliary operation equipment
- Various block adaptations to 15 signal box systems
- Adaptation to relays block

All elements are configured in accordance with the specific project and topography.

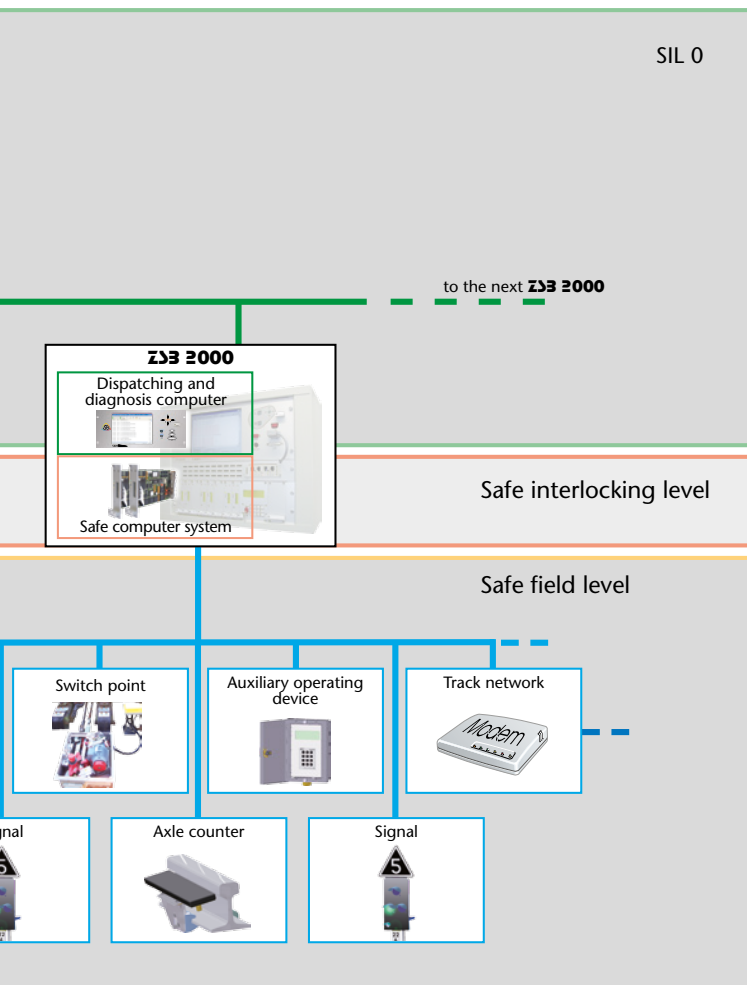

Central Management:

Operational Management; Control- and operating system acc. to SIL0 system architecture

Central operating, displaying, dispatching and interlocking functions:

In the system concept of the interlocking **ZSB 2000**, a central operating console (operating position for dispatcher) is set up for the normal operational management of a track. Via the dispatching and diagnosis bus (DISPO) the station computers are linked with the track computer, which in turn can also serve as the track central operating console for the dispatcher. This operating console provides the dispatcher with a central display and operating desk for the tracks assigned to him. The dispatcher desk is designed according to safety integrity level SIL 0. The safety in respect of signalling is achieved with approved procedures not only for the communication between a particular local interlocking and the dispatcher operating position but also for the operating and displaying functions. The operating and displaying of the track is realized in accordance with customer wishes (e.g. in accordance with the German Railways operating and display concept interlocking ESTW-R and electronic interlocking mode ESZB or in accordance with the unit operating interface of the Austrian Railways ÖBB EBO 2). The following displays can be called in the track centre:

- Representation of the track (overview schematic or overview of the zone)
- Representation of a station (detail screen or station magnifying screen)

In accordance with the project, the display can be distributed to a number of monitors (depending on the project up to 8 monitors for example) so that both the zone overview and the station loupe screen can be active at the same time.

The station loupe screen images are generated automatically by the required information being called in from the stations, i.e. the individual track images are transmitted from the stations to the track centre. As a result only the make-up of the complete track from the individual station loupe screen images has to be designed. Updating of the display images is carried out automatically each time there is a change in the station computer of the interlocking ESTW. In addition an update can be initiated by the track centre if necessary. It is also possible for the dispatcher to call in the setting of routes and to carry out individual- and auxiliary operations, these being safely displayed, processed and transmitted in signalling terms with the aid of various processes such as display, input and command safeguards. Diagnostic information can also be displayed at the dispatcher operating desk.

To enable operations to be carried out automatically, a **ZSB 2000** track can be equipped with a dispatching system. This system outside the safety core is based on the system which is safe in signalling terms and accordingly is at the same level as the operating console. When dispatching is in existence, assistance of the dispatcher is not necessary for the normal progressing of operations. As a result the movement operations are progressed automatically and the

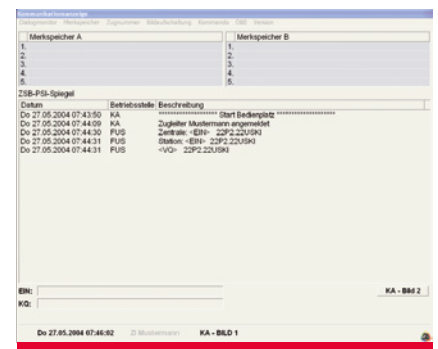
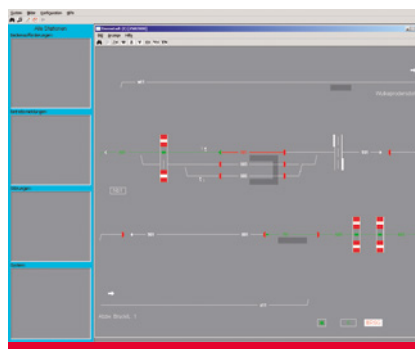
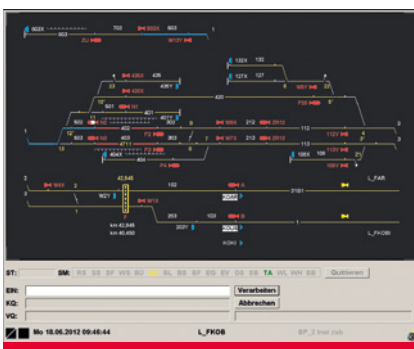

- Dispatching
- Dispatcher operating desk
- Timetable control
- Locating and identifying the trains
- Automatic mode
- Auxiliary operations mode
- Train safeguarding system
- Diagnosis system
- Train steering system
- Service system

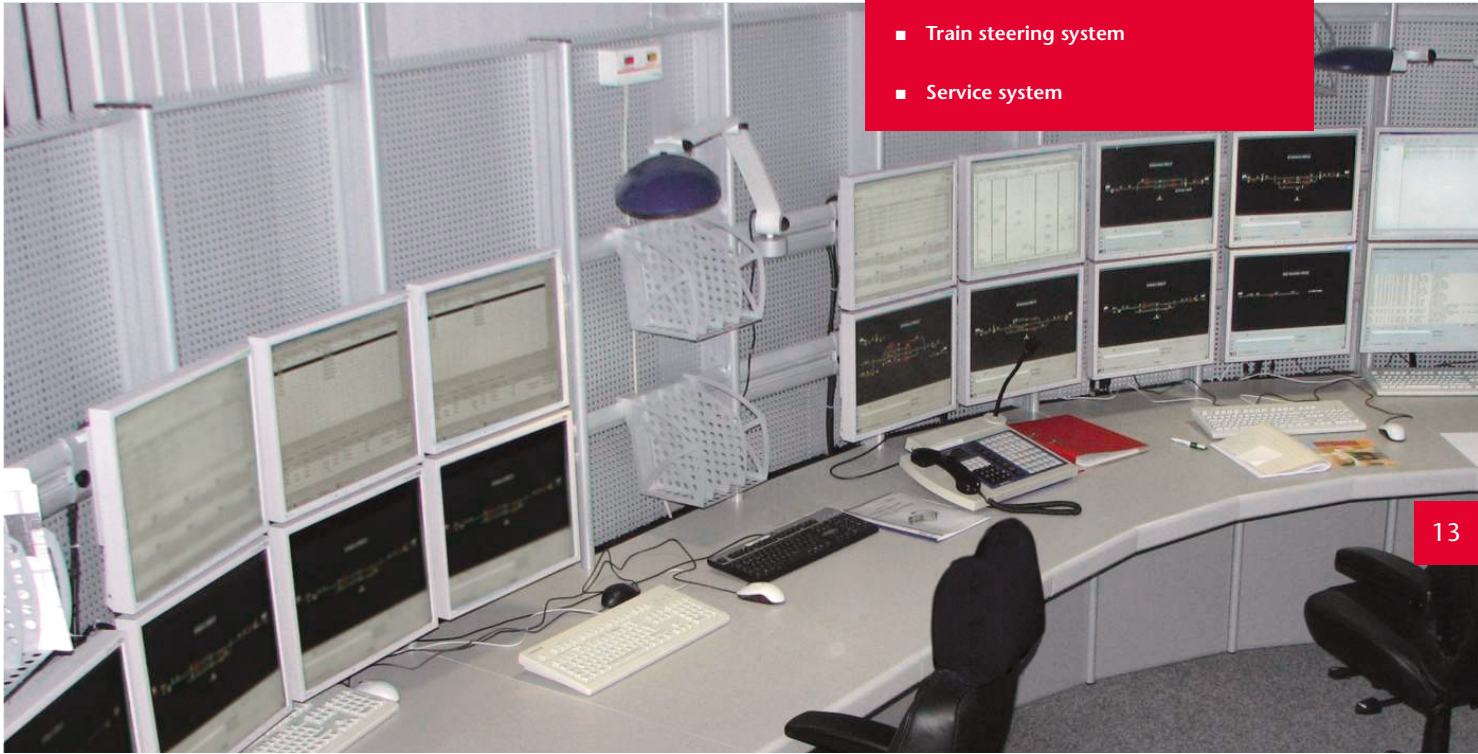

routes needed are set automatically and in good time. To enable these tasks to be realized, the overall **Z33 2000** system is divided into two parts:

- Safeguarding of the roadway. This fulfils the tasks of an interlocking system. These are the safeguarding of the train movements in stations and along the tracks.
- Train control system. This fulfils the dispatching tasks such as locating and identifying the trains in the network and actuating train routes.

The selection of routes is steered by the timetable control, which sets the routes automatically via a timetable stored in the system.

Local operating and display functions:

All **Z33 2000** systems are equipped in the particular setting unit with a dispatching and diagnosis computer which is decoupled from the safety level. This unit, which is designated a station computer, permits the local system to be operated and displayed, this being primarily for the maintenance and service.

The operating possibilities for the operating service can be made available with the auxiliary keys arranged in the outer area. In addition auxiliary actions with responsibility for the safety thereof can be carried out from this device. For these operating actions the collaboration of the dispatcher is essential; however operating with signals always remains possible in the case of disruptions or of a breakdown in communications between interlocking system and dispatcher operating desk.

Efficiency:

A+++ New standards in energy efficiency

In times of scarce resources and rapidly increasing energy costs, energy optimized solutions are more at the forefront of forward-thinking technology than ever before.

At the time of developing the interlocking system **Z3 2000**, particular importance was attached to the use of modern and energy-saving technologies. The consequential separation of energy and information was implemented in the control principle of field elements of this reason. The use of LED signal transducers was favored from the very beginning, whereby

saving potentials can be optimally used with light control via a separate computer in the light, and the loss of energy monitored and minimized.

The full interlocking system **Z3 2000** hardware has been designed so that it can be used without additional heating or air conditioning facilities. The actual control is optimized as a multi-computer system so that use of energy below 100 W is the rule of thumb. This means that the necessary overall power of a train station for all field elements and control in the basic position, performances below 0.5 kW can be easily

achieved. The train station shown in the illustration (station loupe) for example needs a total power of 0.75 kW for its 84 control units (field elements).

This means that the uninterruptible power supply (UPS) can also be kept very streamlined. Crossing stations with a battery capacity of 100 Ah are not an exception and still allow uninterrupted operations management if the power supply network fails. The use of a standard mobile single-phase power unit as an uninterruptible power supply (UPS) is therefore possible without any difficulty.



Integrated Electronic Control Centre (IECC) **Z3 2000** with 0,75 KW total power

For efficient operations management, railway and infrastructure operators require optimised life-cycle costs and sustainable systems alongside favourable investment costs.

The issue of the availability of spare parts (obsolete parts) to achieve the expected periods of use for interlocking and level crossing systems has become a fundamental topic over the past years, especially in electronic systems in control and safety technology.

Scheidt & Bachmann offers long term backward compatibility of its assemblies in the area of signalling components. The continuously growing performance capacity of electronic components is used to

1. be able to integrate function upgrades easily in the future and
2. allow pin compatible replacement of existing assemblies.

In order to be able to turn these two aspects into reality, the corresponding strategic parameters were already created in the basic design. The system architecture of the **Z3B 2000** and **BUES 2000** technology is therefore based on a standardised platform strategy, which exchanges data via a standard communication bus between the internal system and the external system components. Constant functional extension and long-term operating capacity are ensured by the strict separation of hardware and software with backward compatible assemblies but ones that can be permanently developed technologically. The tools common in the micro-electronics market are used for this. One of these is the FPGA (Field Programmable Gate Array), which can be used to personally produce the fundamental and critical ele-

ments of an interlocking system via personal programming. Delivery problems caused by component discontinuation can therefore be targeted and sustainably ruled out as these modules ensure all control and logical functions of the interlocking or level crossing system. This software can therefore be used and upgraded in the long term. This means that Scheidt & Bachmann is capable of producing components in signalling areas in the long term and therefore solving obsolescence problems.

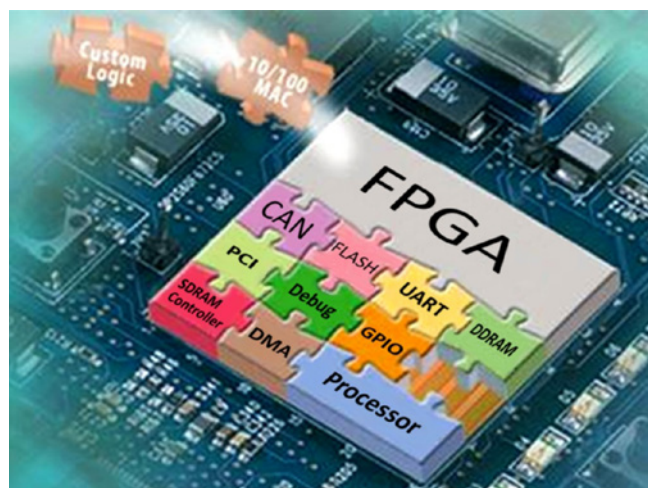

Field Programmable Gate Array (FPGA) as obsolescence strategy

Element	Power requirements
LED signal transducer red 200mm	11,5 W
LED signal transducer yellow 200mm	10 W
LED signal transducer green 200mm	15 W
LED signal transducer white 80mm	6 W
LED signal transducer red 80mm	6 W
LED supplementary signal transducers	26 W
Axle Sensor AZSB 300	3 W
Passing Track / Block Interface	71 W
Example: Station with/up to 4 switch points, 11 axle sensors, 3 pre-signals, 1 multiple block signal, 4 main signals	∅ 400 W
Consumption Values ZSB 2000	

System components:

Modular system concept

The safe data processing centre of the **ZÜB 2000** control centre represents the interlocking level of the electronic interlocking system **ZÜB 2000**. It consists as a rule of 3 modules (2 communication and 1 route module), each having a duplicated computer system. In addition a service keyboard and a duplicated

program and system data memory are provided in the interlocking level. Exclusively data is processed in the interlocking level and no currents are set. The releasing of energy is carried out locally at the actuating element.

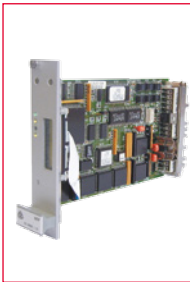

Module processor

In the particular module the module processor realizes the control and monitoring functions relevant for safety. Here the duplicated subassemblies of the field level are checked and diagnosis data is made available for the diagnosis level. This subassembly is identical in terms of construction to the level crossing **ZÜB 2000** module processor.

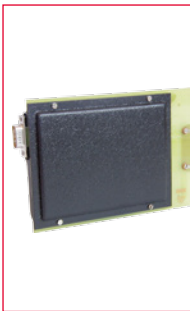

Central program and system store ZPAS

In addition to the type-approved software, the integrated central program and system store ZPAS contains the project data necessary for the specific case of application. When a system is started, the individual modules are loaded appropriately with program and data. This subassembly is identical in terms of construction to the central program and system store ZPAS of the **ZÜB 2000** level crossing system.



Service keyboard

Via a 4-line display and keyboard the service keyboard permits information to be enquired about and the different system reactions to be activated. In addition project data can be read out via a serial interface. This subassembly is identical in terms of construction to the service keyboard of the level crossing system **ZÜB 2000**.

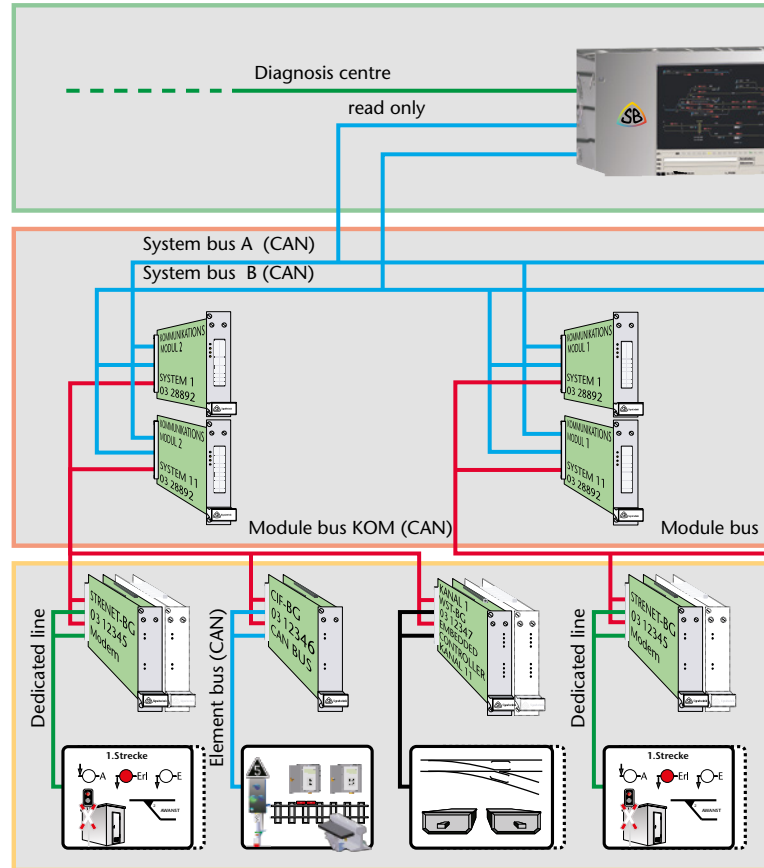

Number of components dependent on the particular project

The field level represents the safe actuator level of the **Z33 2000** interlocking system. It consists of safe microcomputer systems, each of which is duplicated, for the controlling and monitoring of a defined function, the systems being located as a rule on the field element itself and thus not in the interlocking system building. This means that the interlocking system

Z33 2000 can be installed in very small rooms if necessary (approx. 5 m²) and does not need any special air conditioning. The subassemblies of the field level are self-contained units with defined interfaces. The transmission of data between the individual levels, within the modules and to almost all field level elements is carried out via the CAN-BUS (EBUS).

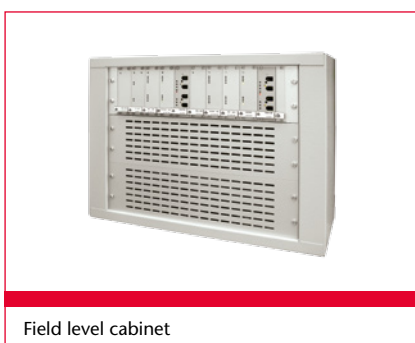
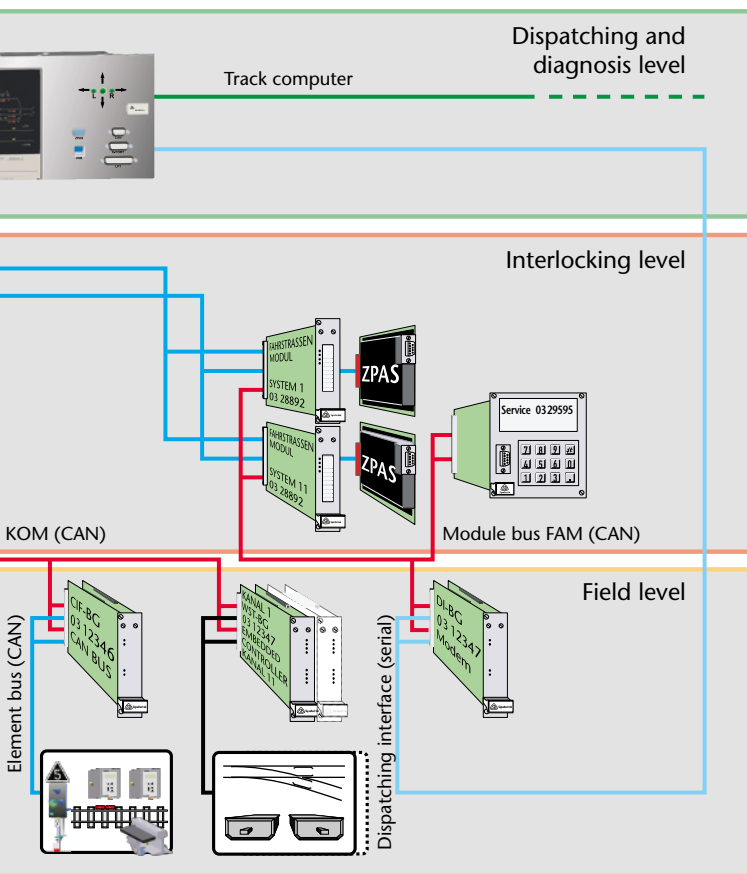

Switch control subassembly WST-BG

The switch control subassembly WST-BG is an electronic subassembly for actuating switch mechanisms whereby the changing and monitoring logic is executed as a redundant computer system. Actuation is realized in accordance with the four-wire circuit principle and switching over between the setting and monitoring operating modes is carried out via positively driven, plug-gable signal relays (Hengstler). One WST-BG can control up to 4 sets of switches.

In/Out subassembly

The In/Out subassembly has 16 inputs and 8 outputs and is used in a module-independent manner where such interfaces (relay controls, key-locked devices) have to be operated. This In/Out subassembly is identical in terms of construction to the In/Out subassembly of the level crossing system **3UES 2000**.

CANInterface subassembly

The CANInterface subassembly CIF-BG makes possible telegram-oriented communication with "intelligent field elements" (e.g. axle counters, signals, local manual user interface - auxiliary keys) via the CAN-bus. In order to be able to bridge large distances, the transmission rate of the internal CAN bus is reduced from 200 kBaud to 10 kBaud on the element bus (EBUS). This subassembly is identical in terms of construction to that in the level crossing system **3UES 2000**.

STRENET subassembly

The STRENET track network subassembly realizes the interface to the track modem. The latter makes possible not only communication with the neighbouring operation points but also the integration of level crossing systems such as the **3UES 2000** or of other level crossing systems with the level-crossing module on the track. To ensure safe realization of the closed track channel, the data is safeguarded with the aid of coding algorithms (EN 50159-1).

Field level components:

Signalling concept

Used in the interlocking system **Z33 2000** are **LED signal transducers**.

Actuation of the signals is brought via a safe electronic subassembly, namely the LSS-BG (Light-Signal-Control Subassembly), which is installed at each main signal location. This subassembly is connected to the safe interlocking level on the EBUS (element bus executed as CAN-bus) and gets transmitted the data for the signal aspects (images) to be displayed. For this the LSS-BG communicates via the SCAN (SignalCAN bus) with the safe processors of the individual LED light points of the main and advance signals and—in so

far as these are present—with the auxiliary signals and speed displays at the location of the specific signal.

Here the individual light points are brought together in a logical signal group and actuated via the SCAN bus per telegram. Thus each optical device possesses its “own intelligence” for the actuation and monitoring of the particular light point. In the case of an interruption in the link to the relevant interlocking level, an appropriate relapse management system in the LSS subassembly is processed.



Light signal control subassembly LSS / intermittent automatic train control subassembly PZB

The individual signal aspects from the interlocking level are transmitted to the light signal control subassembly LSS-BG via the EBUS (CAN-Bus). Then, via the SCAN-Bus (SignalCAN-Bus) the LSS-BG actuates the individual light points per telegram. In addition the PZB (intermittent automatic train control subassembly) solenoids required can be connected in 500/1000/2000 Hz to the LSS-BG or, as the case may be, PZB-BG for advance and auxiliary signals.

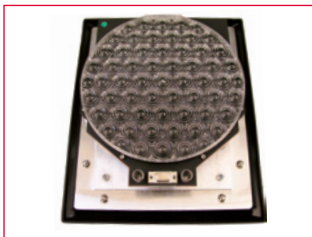

LED signal transducer

The main signal light points are executed as a 200 mm LED optical system. The safe processor for controlling and monitoring is executed together with the optical system as a pluggable unit. The 200 mm light point consists of 64 LEDs, each having a separate lens. The LEDs are monitored and actuated in 8 chains, each of 8 LEDs.



LED supplementary signal transducers

Available for supplementary signals is an 80 mm LED optical system. This can be used, for example, for replacement, light barricade- and mini-signals. These are also actuated by a LSS-BG via the SCAN-Bus per telegram with each optical system being equipped with a safe processor for actuation and monitoring of the particular light point. The 80 mm light point consists of 32 LEDs, each having a separate lens. The LEDs are monitored and actuated in 4 chains, each of 8 LEDs.



LED universal matrix indicator

The matrix displayer is a 10 x 14 LED light point matrix which is safely actuated and monitored in signalling respects by a safe processor whereby each of the 140 LEDs can be switched on and off in a freely programmable manner. In this way each character able to be represented in the matrix can be defined, actuated and monitored per software configuration with one matrix displayer.

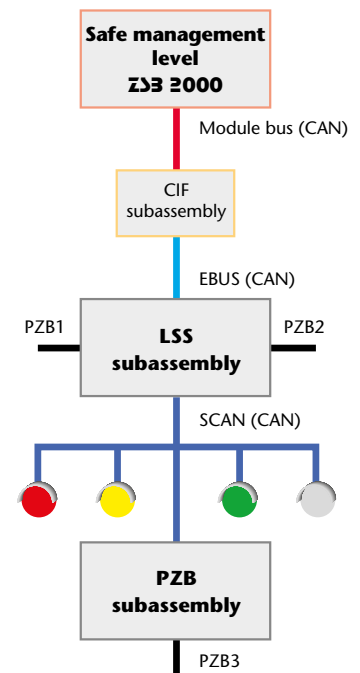

Vehicle capturing concept

Axle counting is an integral component of the **ZSB 2000** logic. Axle counting is not formed as a separate functional unit but as software. Accordingly the sensor system needed for capturing the axles only provides the information "axle and direction" to the **ZSB 2000** interlocking level. The evaluation

of the "axle" information is carried out safely in the interlocking level with the formation of appropriate sections. The transmission of the information between sensor and interlocking is carried out with the aid of EBUS, executed as CAN-Bus (Controller Area Network bus).

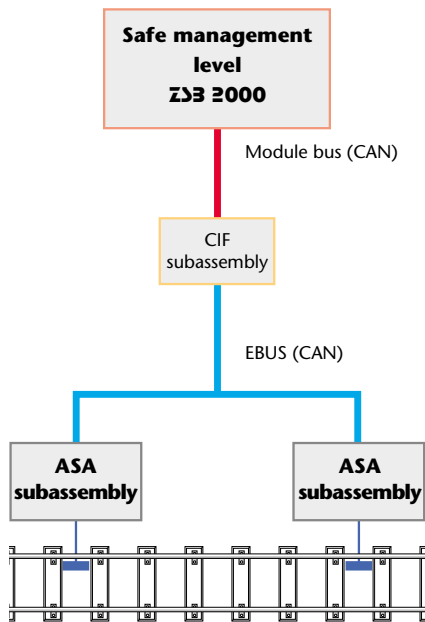

Axle sensor in the track

The axle sensor consists of 2 small induction loops which are integrated in a compact housing, which is screwed to the rail, and which is evaluated in an axle-sensitive manner on the basis of their longitudinal extension. The axle sensor is identical in terms of construction to that in the level crossing system **BUE 2000**.



The axle counter consists of:

- Axle sensor AS
- Axle sensor evaluation subassembly for interlocking system, ASA BG

Axle sensor evaluation subassembly ASA

The axle sensor evaluation subassembly evaluates the data from axle sensor and transmits each axle that is captured from train together with the related direction via the CAN bus. The counting of the axles is carried out in the ZSB interlocking level. This subassembly is identical in terms of construction to that in the level crossing system **BUE 2000**.



Axle sensor on the rail

Axle sensor with universal fastening system

The axle sensor consists of an impact resistant and waterproof welded plastic housing with a universal fastening system for clamping to the rail.

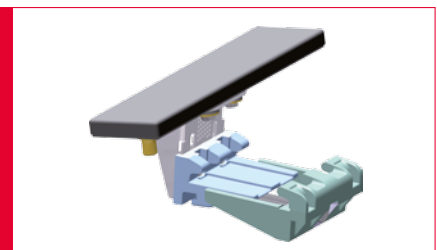

Field level components:

Local man manual user interface concept

In the interlocking system **Z33 2000** additional display and operating devices are provided and used for particular operating situations or for variances from normal operations.

For operating at local level, so-called local man manual user interface equipment (ÖBE) can be used. Here a HST subassembly (Man Manual User Interface Subassembly) is used, this being also connected to the EBUS (element bus as CAN bus). The use of key buttons and operating on the dispatching and diagnosis system are also possible.



Local man manual user interface

A local display and operating device can be provided for maintenance and service. The functions of this device are restricted exclusively to the adjusting range of the related **Z33 2000** system and permit the requesting of routes. The device is combined with the diagnosis system that is present.



User interface

Where requested by the customer, magnified images can be called up and controlled on the station computer belonging to the particular station. To do this the local operator logs on at the station computer. Here the operating possibilities and procedures depend on the particular customer's display and operating system (e.g. EBO2)



Key buttons

For particular cases of application such as passing point junctions (e.g. set of switch), a key blockade device can be fitted. After the device has been enabled, the user can set the roadway on local site via key dependencies. Integration for the operating of mechanical barrier systems is possible.

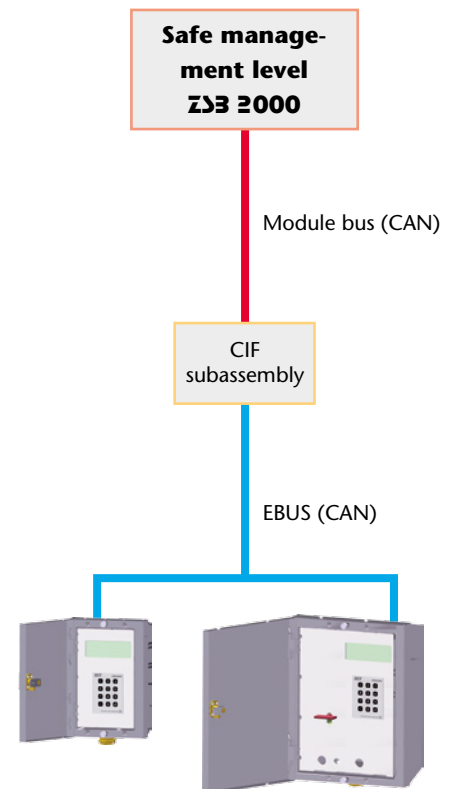



Operating menu

Service concept

Each interlocking system **ZÜB 2000** has a station computer for dispatching and diagnosis tasks. The station computer is linked with the safe system on the one hand in a reaction free manner and on the other hand via a dispatching interface (DISPO).

For diagnosis the CAN telegrams that have been sent on the system bus can be read and displayed with the aid of an analysis program.

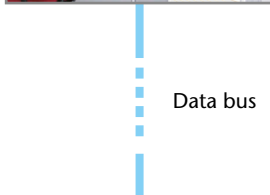
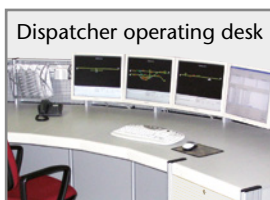

Data bus

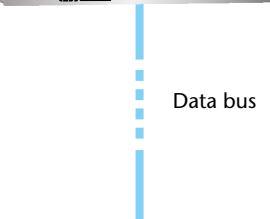
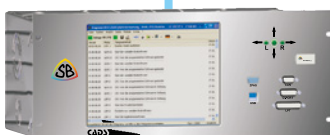

Data bus

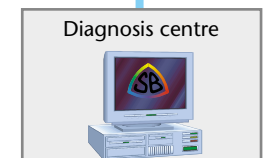

Local diagnosis

A Windows-based diagnostics program is installed on the local PC. This program decodes and stores the telegrams received from the interlocking system **ZÜB 2000**. With the aid of a corresponding data management system, errors and disruptions are prepared and stored for the service and maintenance personnel. The subassembly is identical in terms of construction with the diagnosis system of the level crossing system **ZÜB 2000**.

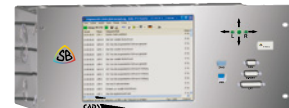

Diagnosis user interface

All data, which is in clear text form and has a time-stamp, is stored in a buffer on the user interface of the diagnosis system. The latest 1000 events can be displayed in a window. The stored data can also be displayed and evaluated via menus.

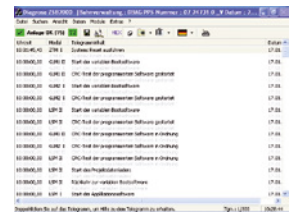

Dedicated line modem

All operation points are linked with the diagnosis centre via a dedicated line modem. In this way data, which has been stored in the local diagnosis system, can be transmitted to the diagnosis centre. Transmission is made on the basis of international standards and standard protocols such as TCP/IP are used.

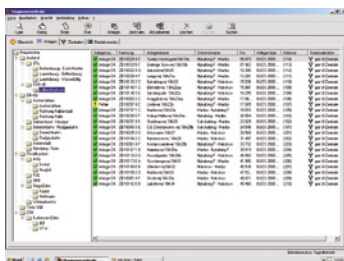

Diagnosis centre user interface

Synergetic effects for our customers: Our systems for a mobile world



Signalling systems

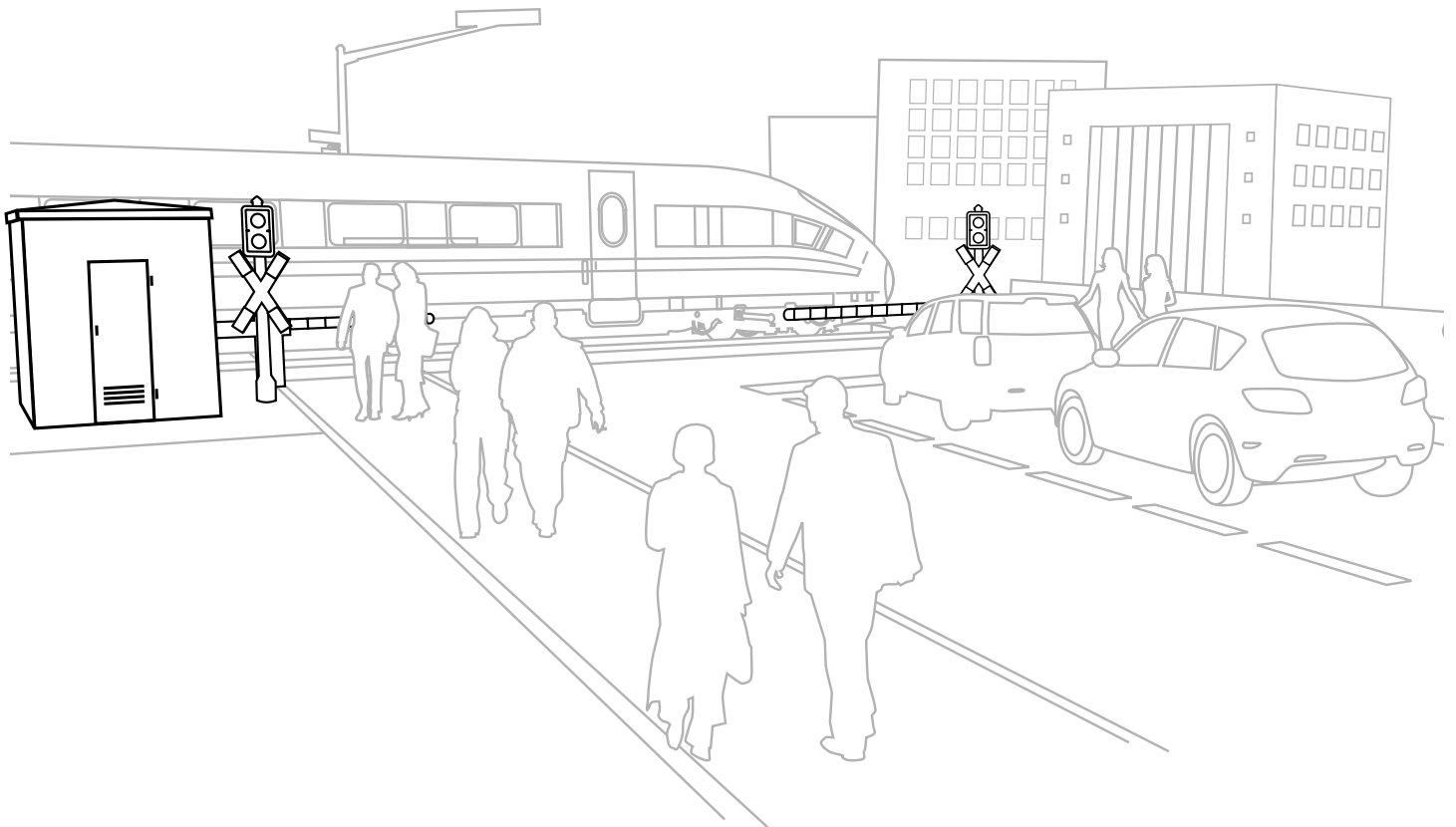

Petrol station systems

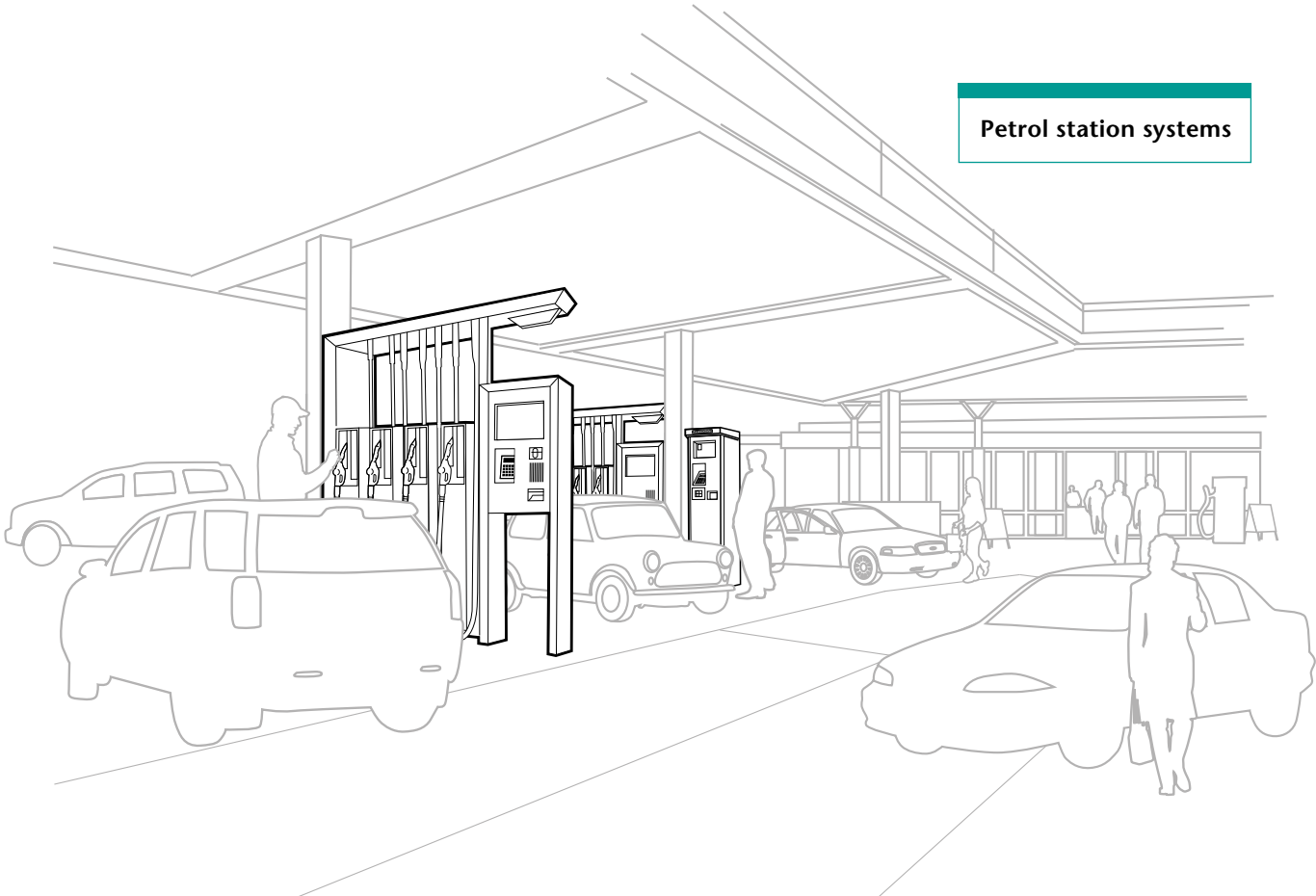

Fare collection systems

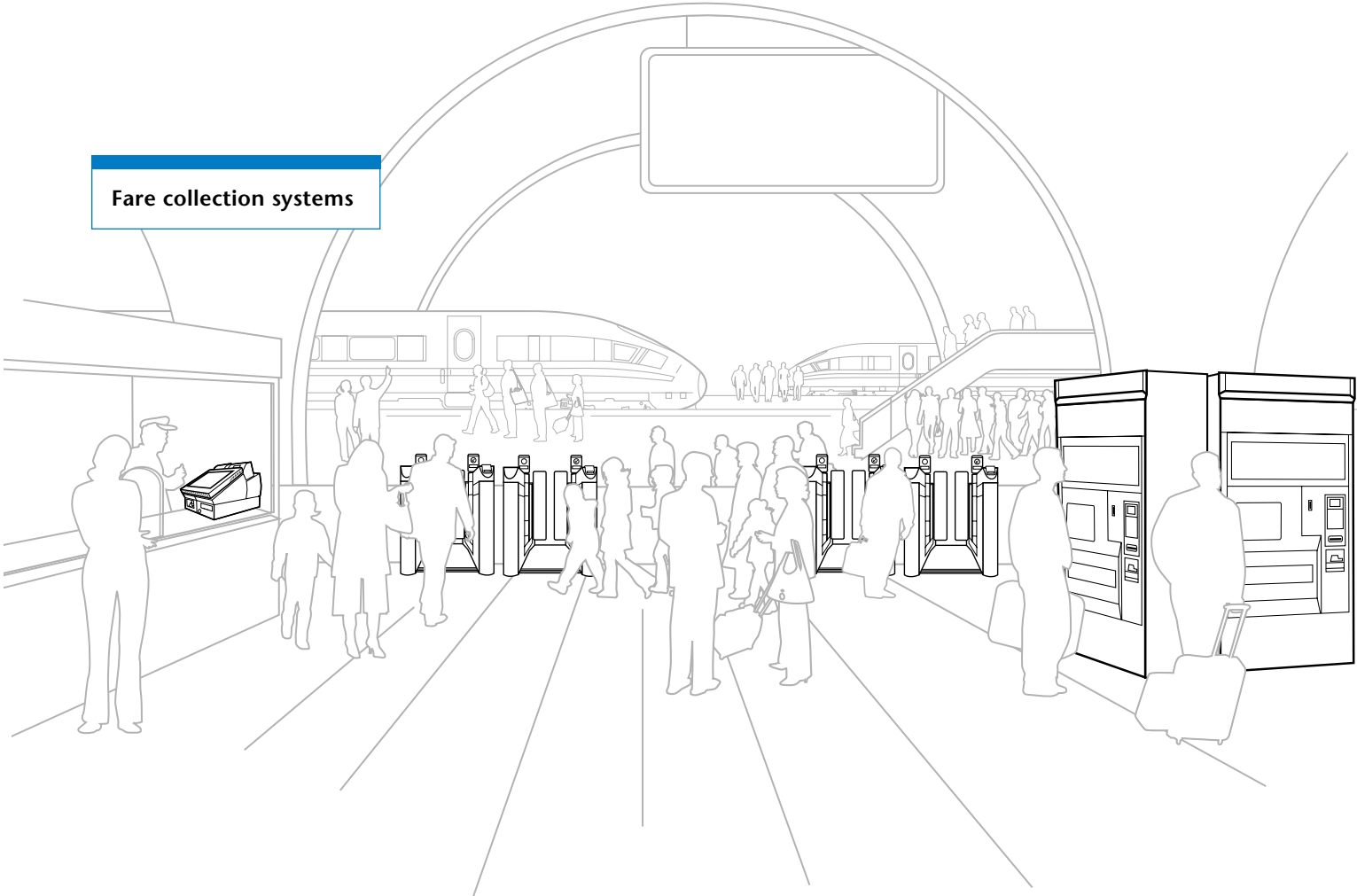

Leisure centre systems

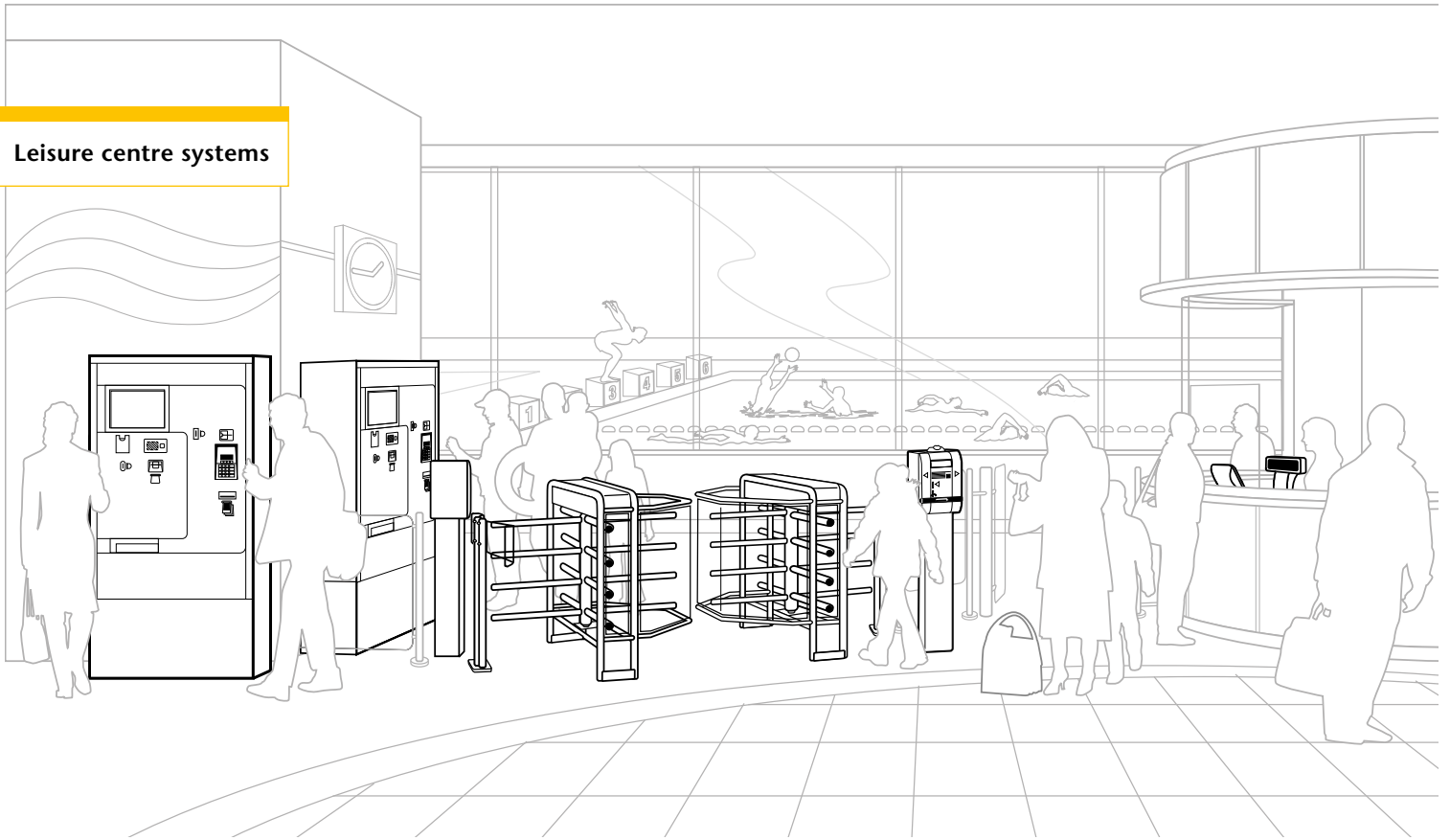

Parking systems





 **Parking and
leisure centre systems**

 **Signalling
systems**

 **Fare collection
systems**

 **Petrol station
systems**

From the ticket machine to the fuel pump, from the turnstile to the level crossing – Scheidt & Bachmann technology surrounds us everywhere. In order to keep people in motion day by day, we consistently think systematically.

We develop, produce, distribute and maintain systems for multi-storey car park and leisure facilities, as well as systems for signal engineering, fare collection management and petrol stations, split into four largely independent fields of distribution.

We always stay true to our philosophy: We systematically introduce innovative processes so that our customers are always one step ahead.

SCHEIDT&BACHMANN 

Scheidt & Bachmann Österreich GmbH
Straubing Straße 4 - A-4030 Linz - Austria
Tel. +43 732 321177-0
Fax +43 732 321177-99
office.linz@scheidt-bachmann.at

Scheidt & Bachmann Polska Spolka z.o.o.
ul. Wąska 15 - 62-030 Luboń - Poland
Tel. +48 61 8306637
Fax +48 618633823
sbp@scheidt-bachmann.pl

Scheidt & Bachmann Slovensko s.r.o.
Priemyselná 14 / P.O.Box B-143 - 012 32 Žilina - Slovakia
Tel. +421 41 5060 111
Fax +421 41 5060 118
sb@scheidt-bachmann.sk

Scheidt & Bachmann Israel Ltd.
Air Port city / P.O.Box 204 - 70150 Ben Gurion - Israel
Tel. +972 3 9792365
Fax +972 3 9730330
office@sbparking.co.il

Scheidt & Bachmann Sverige AB
Stadiongatan 65 - SE-217 62 Malmö - Sweden
Tel. +46 40 6716 600
office.malmo@scheidt-bachmann.se

Scheidt & Bachmann System Technik GmbH
Edisonstrasse 3 - 24145 Kiel - Germany
Tel. + 49 431 2481-488
Fax + 49 431 2481-501
office.kiel@scheidt-bachmann-st.de

Verkehrs- und Industrietechnik AG
Industriestraße 11 - 5432 Neuenhof - Switzerland
Tel. +41 56 4163434
Fax +41 56 4163435
info@vtag.ch

Dunántúli Távközlési és
Biztosítóberendezési Építő Kft.
Vasút u. 22 - 9700 Szombathely - Hungary
Tel. +36 94 324-221/107 m
+36 94 512-553
Fax +36 94 512-580
tbef@dtb.hu

Scheidt & Bachmann GmbH
Signalling Systems / Systeme für Signaltechnik
Breite Straße 132 - 41238 Mönchengladbach
Germany
Phone +49 2166 266-628
Fax +49 2166 266-475
www.scheidt-bachmann.de
signaltechnik@scheidt-bachmann.de

SCHEIDT&BACHMANN 